

Features

- Operating voltage: 2.7V~5.2V
- Built-in RC oscillator
- External 32.768kHz crystal or 32kHz frequency source input
- 1/4 bias, 1/8 duty, frame frequency is 64Hz
- Max. 64×8 patterns, 8 commons, 64 segments
- Built-in internal resistor type bias generator
- 3-wire serial interface
- 8 kinds of time base or WDT selection
- Time base or WDT overflow output
- Built-in LCD display RAM
- R/W address auto increment
- Two selectable buzzer frequencies (2kHz or 4kHz)
- Power down command reduces power consumption
- Software configuration feature
- Data mode and Command mode instructions
- Three data accessing modes
- VLCD pin to adjust LCD operating voltage
- Cascade application
- 100-pin QFP package

General Description

HT1625 is a peripheral device specially designed for I/O type MCU used to expand the display capability. The max. display segment of the device are 512 patterns (64×8). It also supports serial interface, buzzer sound, Watchdog Timer or time base timer functions. The HT1625 is a memory mapping and multi-function LCD controller. The software configuration feature of the

HT1625 make it suitable for multiple LCD applications including LCD modules and display subsystems. Only three lines are required for the interface between the host controller and the HT1625. The HT162X series have many kinds of products that match various applications.

Selection Table

HT162X	HT1620	HT1621	HT1622	HT16220	HT1623	HT1625	HT1626
COM	4	4	8	8	8	8	16
SEG	32	32	32	32	48	64	48
Built-in Osc.	—	√	√	—	√	√	√
Crystal Osc.	√	√	—	√	√	√	√

Block Diagram

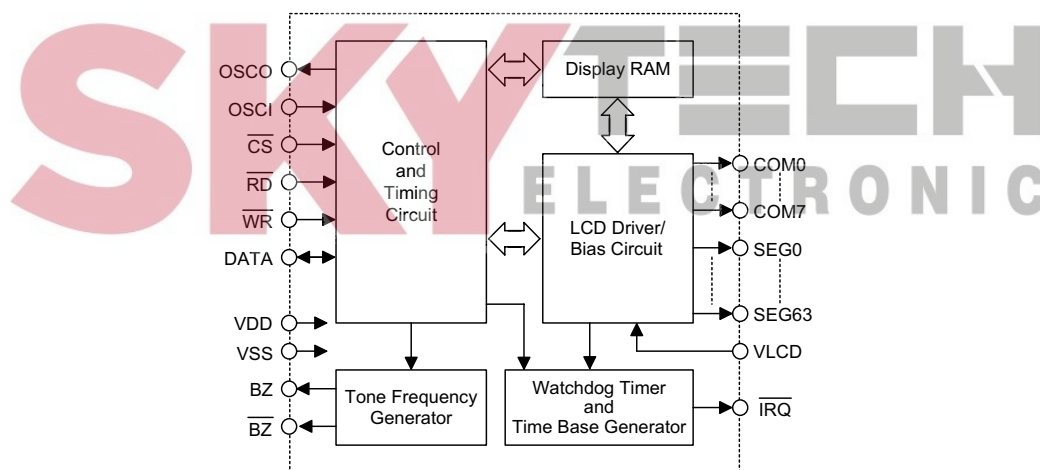

Pin Assignment

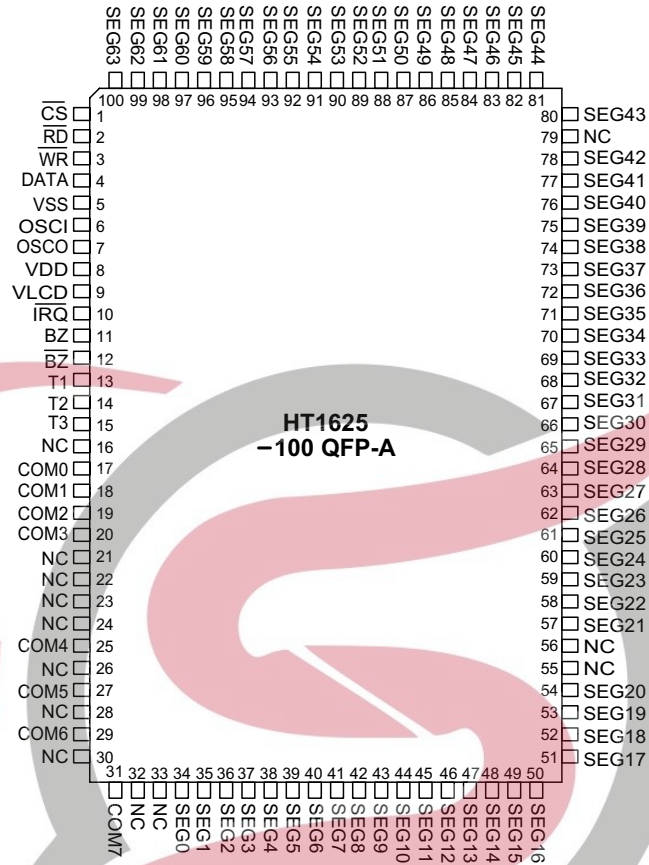

Pad Coordinates

Unit: mil

Pad No.	X	Y	Pad No.	X	Y
1	-90.18	98.56	45	90.57	-84.53
2	-90.18	91.93	46	90.57	-77.90
3	-90.18	85.30	47	89.80	-68.13
4	-90.18	75.95	48	89.80	-61.50
5	-89.42	57.76	49	89.80	-49.51
6	-89.42	45.77	50	89.80	-42.88
7	-90.18	39.14	51	89.80	-30.90
8	-90.18	32.51	52	89.80	-24.27
9	-90.18	25.03	53	89.80	-12.28
10	-90.18	15.94	54	89.80	-5.65
11	-90.18	5.82	55	89.80	6.33
12	-90.18	-3.61	56	89.80	12.96
13	-90.18	-10.24	57	89.80	24.95
14	-90.18	-16.87	58	89.80	31.58
15	-90.18	-23.50	59	89.80	43.56
16	-90.18	-30.13	60	89.80	50.19
17	-90.18	-36.76	61	89.80	62.18
18	-90.18	-43.39	62	89.80	68.81
19	-90.18	-50.02	63	89.80	80.79
20	-83.17	-56.65	64	89.80	87.42
21	-76.54	-63.28	65	89.38	98.22
22	-69.91	-69.91	66	77.39	98.22
23	-63.28	-76.54	67	70.76	98.22
24	-56.65	-83.17	68	58.78	98.22
25	-50.02	-89.80	69	52.15	98.22
26	-43.39	-96.43	70	40.16	98.22
27	-36.76	-103.06	71	32.09	99.32
28	-30.13	-109.69	72	25.46	99.32
29	-23.50	-116.32	73	18.83	99.32
30	-16.87	-122.95	74	12.20	99.32
31	-10.24	-129.58	75	5.57	99.32
32	-3.61	-136.21	76	-1.06	99.32
33	3.02	-142.84	77	-7.69	99.32
34	9.65	-149.47	78	-14.32	99.32
35	16.28	-156.10	79	-20.95	99.32
36	22.91	-162.73	80	-27.58	99.32
37	29.54	-169.36	81	-34.21	99.32
38	41.52	-175.99	82	-40.84	99.32
39	48.15	-182.62	83	-47.47	99.32
40	60.14	-189.25	84	-54.10	99.32
41	66.77	-195.88	85	-60.73	99.32
42	78.75	-202.51	86	-67.36	99.32
43	90.57	-209.14	87	-73.99	99.32
44	90.57	-215.77			

Pad Description

Pad No.	Pad Name	I/O	Description
1	\overline{RD}	I	READ clock input with pull-high resistor. Data in the RAM of the HT1625 are clocked out on the falling edge of the \overline{RD} signal. The clocked out data will appear on the data line. The host controller can use the next rising edge to latch the clocked out data.
2	\overline{WR}	I	WRITE clock input with pull-high resistor. Data on the DATA line are latched into the HT1625 on the rising edge of the \overline{WR} signal.
3	DATA	I/O	Serial data input or output with pull-high resistor
4	VSS	—	Negative power supply, ground
5	OSCI	I	The OSCI and OSCO pads are connected to a 32.768kHz crystal in order to generate a system clock. If the system clock comes from an external clock source, the external clock source should be connected to the OSCI pad. But if an on-chip RC oscillator is selected instead, the OSCI and OSCO pads can be left open.
6	OSCO	O	
7	VDD	—	Positive power supply
8	VLCD	I	LCD operating voltage input pad.
9	\overline{IRQ}	O	Time base or Watchdog Timer overflow flag, NMOS open drain output
10, 11	BZ, \overline{BZ}	O	2kHz or 4kHz tone frequency output pair
12~14	T1~T3	I	Not connected
15~22	COM0~COM7	O	LCD common outputs
23~86	SEG0~SEG63	O	LCD segment outputs
87	\overline{CS}	I	Chip selection input with pull-high resistor. When the \overline{CS} is logic high, the data and command read from or write to the HT1625 are disabled. The serial interface circuit is also reset. But if the \overline{CS} is at logic low level and is input to the \overline{CS} pad, the data and command transmission between the host controller and the HT1625 are all enabled.

Absolute Maximum Ratings

Supply Voltage -0.3V to 5.5V Storage Temperature -50°C to 125°C
 Input Voltage $V_{SS}-0.3V$ to $V_{DD}+0.3V$ Operating Temperature -25°C to 75°C

Note: These are stress ratings only. Stresses exceeding the range specified under "Absolute Maximum Ratings" may cause substantial damage to the device. Functional operation of this device at other conditions beyond those listed in the specification is not implied and prolonged exposure to extreme conditions may affect device reliability.

D.C. Characteristics

Ta=25°C

Symbol	Parameter	Test Conditions		Min.	Typ.	Max.	Unit
		V _{DD}	Conditions				
V _{DD}	Operating Voltage	—	—	2.7	—	5.2	V
I _{DD1}	Operating Current	3V	No load or LCD ON	—	155	310	μA
		5V	On-chip RC oscillator	—	260	420	μA
I _{DD2}	Operating Current	3V	No load or LCD ON	—	150	310	μA
		5V	Crystal oscillator	—	250	420	μA
I _{DD11}	Operating Current	3V	No load or LCD OFF	—	8	30	μA
		5V	On-chip RC oscillator	—	20	60	μA
I _{DD22}	Operating Current	3V	No load or LCD OFF	—	—	20	μA
		5V	Crystal oscillator	—	—	35	μA
I _{STB}	Standby Current	3V	No load, Power down mode	—	1	12	μA
		5V		—	2	24	μA
V _{IL}	Input Low Voltage	3V	DATA, $\overline{\text{WR}}$, $\overline{\text{CS}}$, $\overline{\text{RD}}$	0	—	0.6	V
		5V		0	—	1.0	V
V _{IH}	Input High Voltage	3V	DATA, $\overline{\text{WR}}$, $\overline{\text{CS}}$, $\overline{\text{RD}}$	2.4	—	3	V
		5V		4.0	—	5	V
I _{OL1}	BZ, $\overline{\text{BZ}}$, $\overline{\text{IRQ}}$	3V	V _{OL} =0.3V	0.9	1.8	—	mA
		5V	V _{OL} =0.5V	1.7	3	—	mA
I _{OH1}	BZ, $\overline{\text{BZ}}$	3V	V _{OH} =2.7V	-0.9	-1.8	—	mA
		5V	V _{OH} =4.5V	-1.7	-3	—	mA
I _{OL1}	DATA	3V	V _{OL} =0.3V	0.9	1.8	—	mA
		5V	V _{OL} =0.5V	1.7	3	—	mA
I _{OH1}	DATA	3V	V _{OH} =2.7V	-0.9	-1.8	—	mA
		5V	V _{OH} =4.5V	-1.7	-3	—	mA
I _{OL2}	LCD Common Sink Current	3V	V _{OL} =0.3V	80	160	—	μA
		5V	V _{OL} =0.5V	180	360	—	μA
I _{OH2}	LCD Common Source Current	3V	V _{OH} =2.7V	-40	-80	—	μA
		5V	V _{OH} =4.5V	-90	-180	—	μA
I _{OL3}	LCD Segment Sink Current	3V	V _{OL} =0.3V	50	100	—	μA
		5V	V _{OL} =0.5V	120	240	—	μA
I _{OH3}	LCD Segment Source Current	3V	V _{OH} =2.7V	-30	-60	—	μA
		5V	V _{OH} =4.5V	-70	-140	—	μA
R _{PH}	Pull-high Resistor	3V	DATA, $\overline{\text{WR}}$, $\overline{\text{CS}}$, $\overline{\text{RD}}$	100	200	300	kΩ
		5V		50	100	150	kΩ

A.C. Characteristics

Ta=25°C

Symbol	Parameter	Test Conditions		Min.	Typ.	Max.	Unit
		V _{DD}	Conditions				
f _{sys1}	System Clock	3V	On-chip RC oscillator	22	32	40	kHz
		5V		24	32	40	
f _{sys2}	System Clock	3V	External clock source	—	32	—	kHz
		5V		—	32	—	
f _{LCD1}	LCD Frame Frequency	3V	On-chip RC oscillator	44	64	80	Hz
		5V		48	64	80	
f _{LCD2}	LCD Frame Frequency	3V	External clock source	—	64	—	Hz
		5V		—	64	—	
t _{COM}	LCD Common Period	—	n: Number of COM	—	n/f _{LCD}	—	sec
f _{CLK1}	Serial Data Clock (\overline{WR} Pin)	3V	Duty cycle 50%	—	—	150	kHz
		5V		—	—	300	
f _{CLK2}	Serial Data Clock (\overline{RD} Pin)	3V	Duty cycle 50%	—	—	75	kHz
		5V		—	—	150	
t _{CS}	Serial Interface Reset Pulse Width (Figure 3)	—	\overline{CS}	—	250	—	ns
t _{CLK}	\overline{WR} , \overline{RD} Input Pulse Width (Figure 1)	3V	Write mode	3.34	—	—	μs
			Read mode	6.67	—	—	
		5V	Write mode	1.67	—	—	μs
			Read mode	3.34	—	—	
t _r , t _f	Rise or Fall Time Serial Data Clock Width (Figure 1)	3V	—	—	120	—	ns
		5V					
t _{su}	Setup Time for DATA to \overline{WR} , \overline{RD} Clock Width (Figure 2)	3V	—	—	120	—	ns
		5V					
t _h	Hold Time for DATA to \overline{WR} , \overline{RD} Clock Width (Figure 2)	3V	—	—	120	—	ns
		5V					
t _{su1}	Setup Time for CS to \overline{WR} , \overline{RD} Clock Width (Figure 3)	3V	—	—	100	—	ns
		5V					
t _{h1}	Hold Time for CS to \overline{WR} , \overline{RD} Clock Width (Figure 3)	3V	—	—	100	—	ns
		5V					

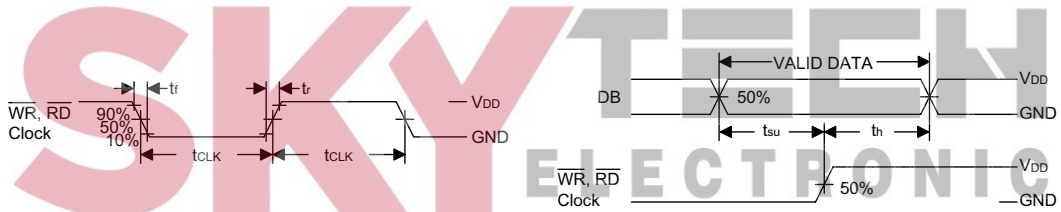

Figure 1

Figure 2

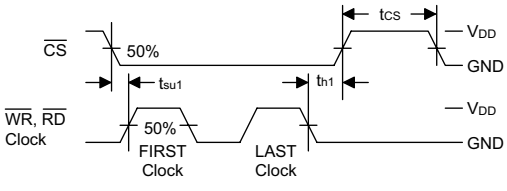

Figure 3

Functional Description

Display memory – RAM structure

The static display RAM is organized into 128x4 bits and stores the display data. The contents of the RAM are directly mapped to the contents of the LCD driver. Data in the RAM can be accessed by the READ, WRITE and READ-MODIFY-WRITE commands. The following is a mapping from the RAM to the LCD patterns.

Time base and Watchdog Timer – WDT

The time base generator and WDT share the same divided (/256) counter. TIMER DIS/EN/CLR, WDT DIS/EN/CLR and IRQ EN/DIS are independent from each other. Once the WDT time-out occurs, the $\overline{\text{IRQ}}$ pin will remain at logic low level until the CLR WDT or the $\overline{\text{IRQ DIS}}$ command is issued.

If an external clock is selected as the source of system frequency, the SYS DIS command turns out invalid and the power down mode fails to be carried out until the external clock source is removed.

Buzzer tone output

A simple tone generator is implemented in the HT1625. The tone generator can output a pair of differential driving signals on the BZ and $\overline{\text{BZ}}$ which are used to generate a single tone.

Command format

The HT1625 can be configured by the software setting. There are two mode commands to configure the HT1625 resource and to transfer the LCD display data.

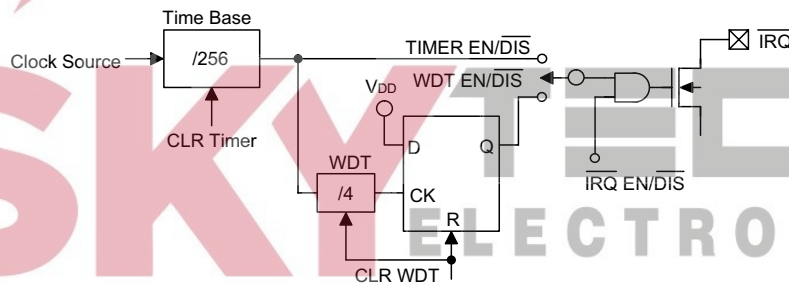
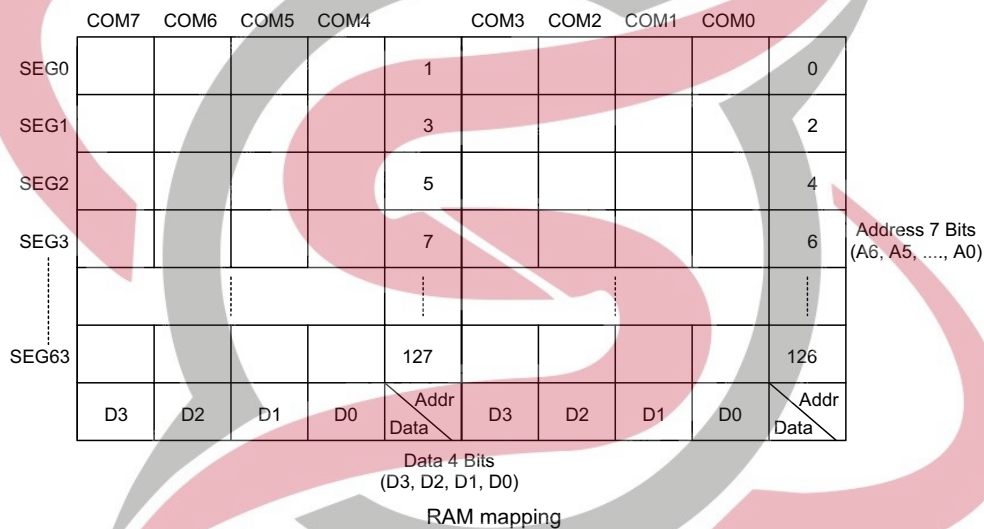

Timer and WDT configurations

The following are the data mode ID and the command mode ID:

Operation	Mode	ID
READ	Data	1 1 0
WRITE	Data	1 0 1
READ-MODIFY-WRITE	Data	1 0 1
COMMAND	Command	1 0 0

If successive commands have been issued, the command mode ID can be omitted. While the system is operating in the non-successive command or the non-successive address data mode, the CS pin should be set to "1" and the previous operation mode will be re-set also. The CS pin returns to "0", a new operation mode ID should be issued first.

Name	Command Code	Function
TONE OFF	0000-1000-X	Turn-off tone output
TONE 4K	010X-XXXX-X	Turn-on tone output, tone frequency is 4kHz
TONE 2K	0110-XXXX-X	Turn-on tone output, tone frequency is 2kHz

Timing Diagrams

READ mode (command code : 1 1 0)

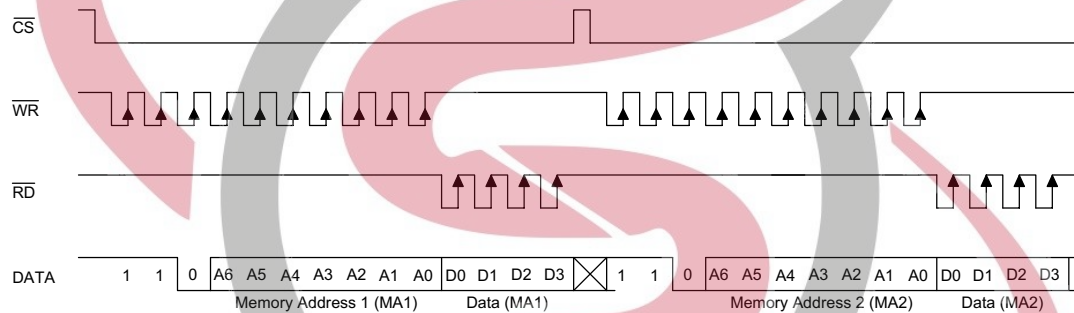

READ mode (successive address reading)

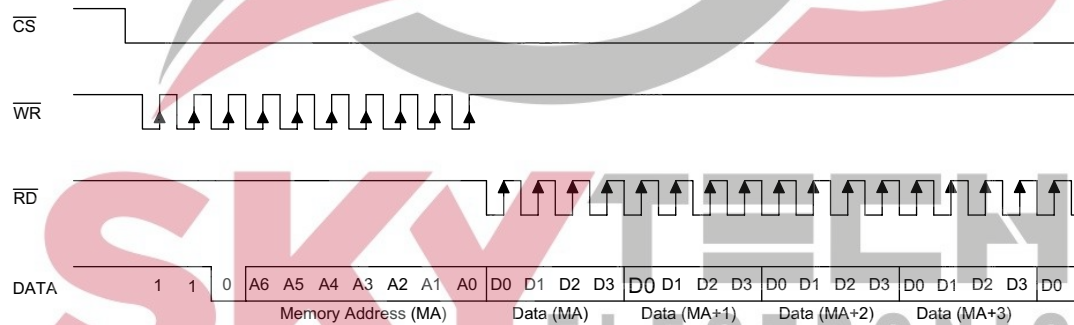

WRITE mode (command code : 1 0 1)

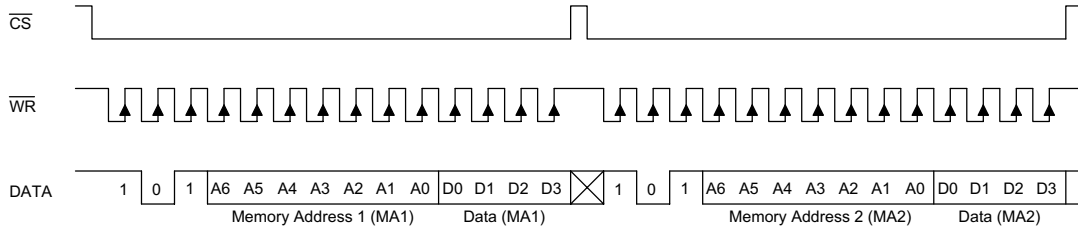

WRITE mode (successive address writing)

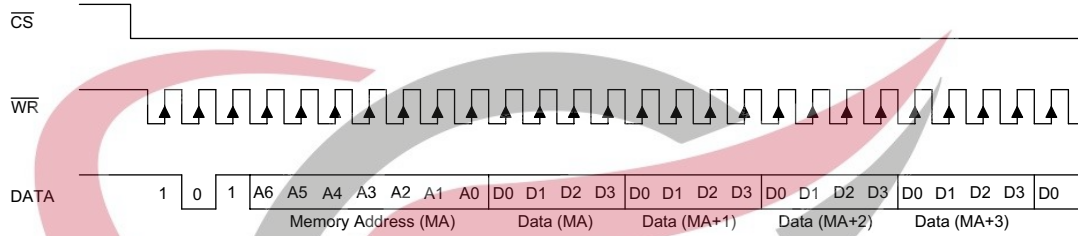

READ-MODIFY-WRITE mode (command code : 1 0 1)

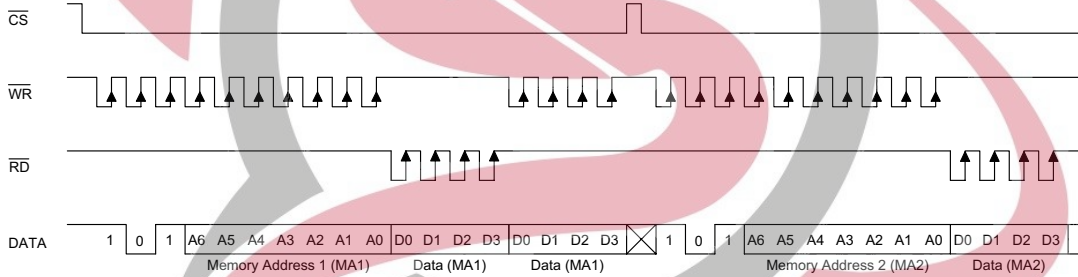

READ-MODIFY-WRITE mode (successive address accessing)

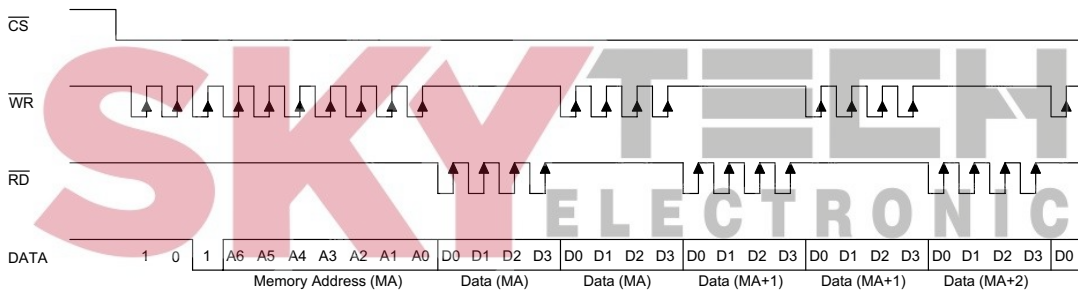

Command mode (command code : 1 0 0)

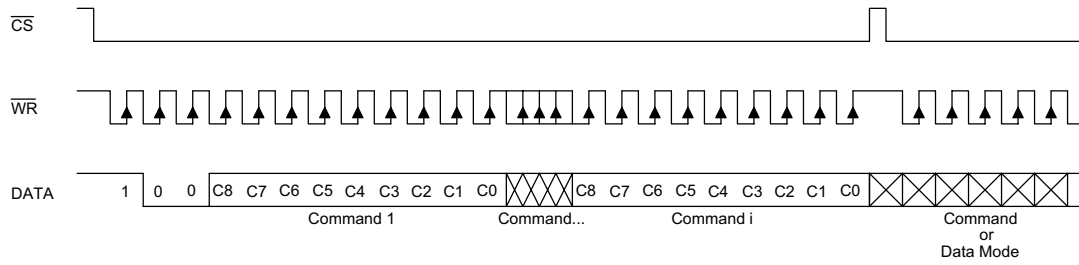

Mode (data and command mode)

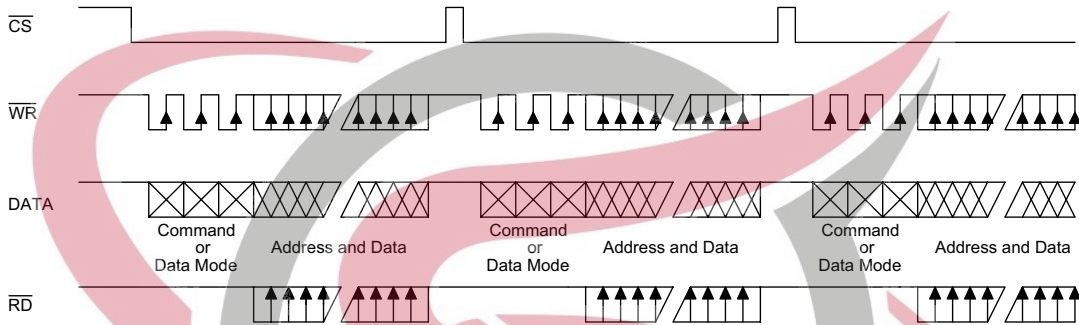

Application Circuits

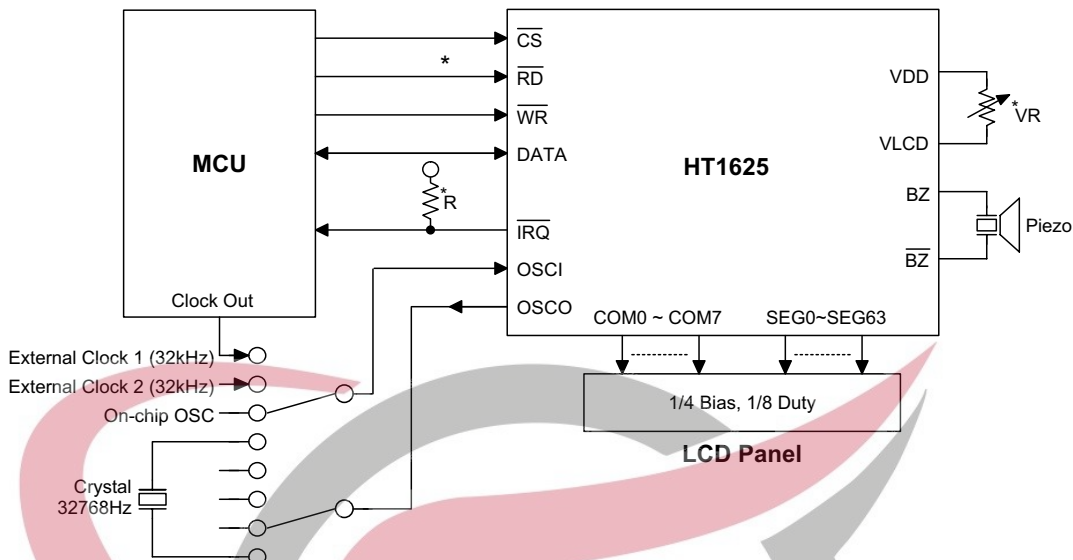

Note: The connection of \overline{IRQ} and \overline{RD} pin can be selected depending on the requirement of the MCU.
 The voltage applied to V_{LCD} pin must be lower than V_{DD} .
 Adjust VR to fit LCD display, at $V_{DD}=5V$, $V_{LCD}=4V$, $VR=15k\Omega\pm 20\%$.
 Adjust R (external Pull-high resistance) to fit user's time base clock.

Instruction Set Summary

Name	ID	Command Code	D/C	Function	Def.
READ	1 1 0	A6A5A4A3A2A1A0D0D1D2D3	D	Read data from the RAM	
WRITE	1 0 1	A6A5A4A3A2A1A0D0D1D2D3	D	Write data to the RAM	
READ-MODIFY-WRITE	1 0 1	A6A5A4A3A2A1A0D0D1D2D3	D	Read and Write data to the RAM	
SYS DIS	1 0 0	0000-0000-X	C	Turn off both system oscillator and LCD bias generator	Yes
SYS EN	1 0 0	0000-0001-X	C	Turn on system oscillator	
LCD OFF	1 0 0	0000-0010-X	C	Turn off LCD display	Yes
LCD ON	1 0 0	0000-0011-X	C	Turn on LCD display	
TIMER DIS	1 0 0	0000-0100-X	C	Disable time base output	Yes
WDT DIS	1 0 0	0000-0101-X	C	Disable WDT time-out flag output	Yes
TIMER EN	1 0 0	0000-0110-X	C	Enable time base output	
WDT EN	1 0 0	0000-0111-X	C	Enable WDT time-out flag output	
TONE OFF	1 0 0	0000-1000-X	C	Turn off tone outputs	Yes
CLR TIMER	1 0 0	0000-1101-X	C	Clear the contents of the time base generator	
CLR WDT	1 0 0	0000-1111-X	C	Clear the contents of the WDT stage	
RC 32K	1 0 0	0001-10XX-X	C	System clock source, on-chip RC oscillator	Yes
EXT (XTAL) 32K	1 0 0	0001-11XX-X	C	System clock source, external 32kHz clock source or crystal oscillator 32.768kHz	

Name	ID	Command Code	D/C	Function	Def.
TONE 4K	1 0 0	010X-XXXX-X	C	Tone frequency output: 4kHz	
TONE 2K	1 0 0	0110-XXXX-X	C	Tone frequency output: 2kHz	
$\overline{\text{IRQ}} \text{ DIS}$	1 0 0	100X-0XXX-X	C	Disable $\overline{\text{IRQ}}$ output	Yes
$\overline{\text{IRQ}} \text{ EN}$	1 0 0	100X-1XXX-X	C	Enable $\overline{\text{IRQ}}$ output	
F1	1 0 0	101X-0000-X	C	Time base clock output: 1Hz The WDT time-out flag after: 4s	
F2	1 0 0	101X-0001-X	C	Time base clock output: 2Hz The WDT time-out flag after: 2s	
F4	1 0 0	101X-0010-X	C	Time base clock output: 4Hz The WDT time-out flag after: 1s	
F8	1 0 0	101X-0011-X	C	Time base clock output: 8Hz The WDT time-out flag after: 1/2s	
F16	1 0 0	101X-0100-X	C	Time base clock output: 16Hz The WDT time-out flag after: 1/4s	
F32	1 0 0	101X-0101-X	C	Time base clock output: 32Hz The WDT time-out flag after: 1/8s	
F64	1 0 0	101X-0110-X	C	Time base clock output: 64Hz The WDT time-out flag after: 1/16s	
F128	1 0 0	101X-0111-X	C	Time base clock output: 128Hz The WDT time-out flag after: 1/32s	Yes
TEST	1 0 0	1110-0000-X	C	Test mode, user don't use.	
NORMAL	1 0 0	1110-0011-X	C	Normal mode	Yes

Note: X : Don't care

A6~A0 : RAM address

D3~D0 : RAM data

D/C : Data/Command mode

Def. : Power on reset default

All the bold forms, namely **1 1 0**, **1 0 1**, and **1 0 0**, are mode commands. Of these, **1 0 0** indicates the command mode ID. If successive commands have been issued, the command mode ID except for the first command will be omitted. The source of the tone frequency and of the time base or WDT clock frequency can be derived from an on-chip 32kHz RC oscillator, a 32.768kHz crystal oscillator, or an external 32kHz clock. Calculation of the frequency is based on the system frequency sources as stated above. It is recommended that the host controller should initialize the HT1625 after power on reset, for power on reset may fail, which in turn leads to the malfunctioning of the HT1625.

Package Information

100-pin QFP (14×20) outline dimensions

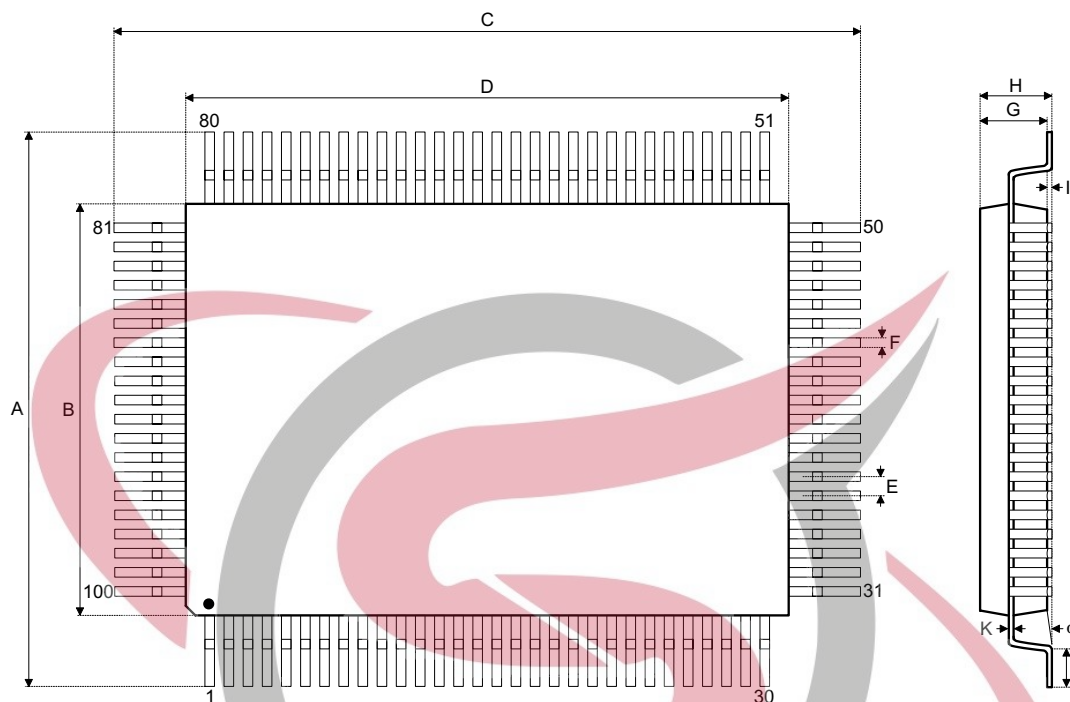

Symbol	Dimensions in mm		
	Min.	Nom.	Max.
A	18.50	—	19.20
B	13.90	—	14.10
C	24.50	—	25.20
D	19.90	—	20.10
E	—	0.65	—
F	—	0.30	—
G	2.50	—	3.10
H	—	—	3.40
I	—	0.10	—
J	1	—	1.40
K	0.10	—	0.20
α	0°	—	7°

Holtek Semiconductor Inc. (Headquarters)

No.3, Creation Rd. II, Science Park, Hsinchu, Taiwan
Tel: 886-3-563-1999
Fax: 886-3-563-1189
<http://www.holtek.com.tw>

Holtek Semiconductor Inc. (Taipei Sales Office)

4F-2, No. 3-2, YuanQu St., Nankang Software Park, Taipei 115, Taiwan
Tel: 886-2-2655-7070
Fax: 886-2-2655-7373
Fax: 886-2-2655-7383 (International sales hotline)

Holtek Semiconductor Inc. (Shanghai Sales Office)

7th Floor, Building 2, No.889, Yi Shan Rd., Shanghai, China 200233
Tel: 021-6485-5560
Fax: 021-6485-0313
<http://www.holtek.com.cn>

Holtek Semiconductor Inc. (Shenzhen Sales Office)

5/F, Unit A, Productivity Building, Cross of Science M 3rd Road and Gaoxin M 2nd Road, Science Park, Nanshan District, Shenzhen, China 518057
Tel: 0755-8616-9908, 8616-9308
Fax: 0755-8616-9533

Holtek Semiconductor Inc. (Beijing Sales Office)

Suite 1721, Jinyu Tower, A129 West Xuan Wu Men Street, Xicheng District, Beijing, China 100031
Tel: 010-6641-0030, 6641-7751, 6641-7752
Fax: 010-6641-0125

Holtek Semiconductor Inc. (Chengdu Sales Office)

709, Building 3, Champagne Plaza, No.97 Dongda Street, Chengdu, Sichuan, China 610016
Tel: 028-6653-6590
Fax: 028-6653-6591

Holmate Semiconductor, Inc. (North America Sales Office)

46729 Fremont Blvd., Fremont, CA 94538
Tel: 510-252-9880
Fax: 510-252-9885
<http://www.holmate.com>

Copyright © 2002 by HOLTEK SEMICONDUCTOR INC.

The information appearing in this Data Sheet is believed to be accurate at the time of publication. However, Holtek assumes no responsibility arising from the use of the specifications described. The applications mentioned herein are used solely for the purpose of illustration and Holtek makes no warranty or representation that such applications will be suitable without further modification, nor recommends the use of its products for application that may present a risk to human life due to malfunction or otherwise. Holtek's products are not authorized for use as critical components in life support devices or systems. Holtek reserves the right to alter its products without prior notification. For the most up-to-date information, please visit our web site at <http://www.holtek.com.tw>.